



SB Connector 50 Amp Series



Dimensions
Metric dimensions are shown in *italics* (mm)

A	B	C	D	E	F	G	H	I
.750	.250	.688	1.375	1.891	3.204	.453	.625	.150
<i>19.00</i>	<i>6.40</i>	<i>17.46</i>	<i>34.93</i>	<i>48.02</i>	<i>81.38</i>	<i>11.51</i>	<i>15.88</i>	<i>3.81</i>

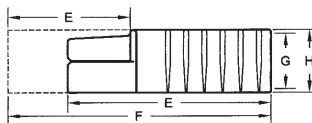
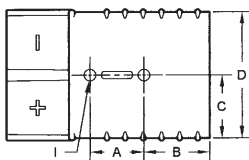

Housing w/springs & 2 contacts	Wire AWG	Anderson Part #	Brad Harrison #	Part #	Anderson Original #
Gray 50 amp	#6	6319	49010	000 317-1720-P	000 317-1720
	#10/#12	6319G1	49012	000 317-1721-P	000 317-1721
Red 50 amp	#6	6331G1	49050	000 317-1719-P	000 317-1719
	#10/#12	6331G2	49051	000 317-1717-P	000 317-1717
Black 50 amp	#6	6331G3		000 317-1718-P	000 317-1718
	#10/#12	6331G4		000 317-1716-P	000 317-1716

Housing w/springs	Anderson Part #	Brad Harrison #	Part #	Anderson Original #
Gray 50 amp	992	66-0090	000 318-1720-P	000 318-1720
Red 50 amp	992G1	66-0091	000 318-1719-P	000 318-1719
Black 50 amp	992G2		000 318-1718-P	000 318-1718

Contact Sets:	Wire AWG	Anderson Part #	Brad Harrison #	Part #
	#6	903G1	66-0120	000 317-5000
	#10/#12	904G1		000 317-5001

Accessories	Anderson Part #	Part #
Handle	SB50-HDL	000 317-1132
Cable Clamps	990	000 317-1143



SB Connector 175 Amp Series

Dimensions
Metric dimensions are shown in italics (mm)

A	B	C	D	E	F	G	H	I
1.125	.438	1.030	2.063	3.125	5.265	.750	1.000	.265
<i>28.57</i>	<i>11.11</i>	<i>26.16</i>	<i>52.40</i>	<i>79.38</i>	<i>133.73</i>	<i>19.05</i>	<i>25.40</i>	<i>6.73</i>

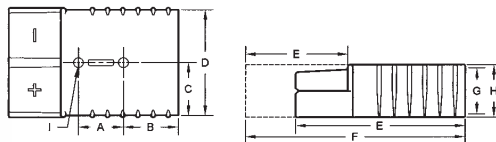

SB Connector 175 Amp 2-Pole Series

Housing w/springs & 2 contacts	Wire AWG	Anderson Part #	Brad Harrison #	Anderson Original #
Gray 175 amp	1/0	6325G1	49110	000 317-1752-P 000 317-1752
Blue 175 amp	1/0	6326G1	49120	000 317-1753-P 000 317-1753
Orange 175 amp	1/0	6327G1	49130	000 317-1754-P 000 317-1754
Yellow 175 amp	1/0	6328G1	49140	000 317-1755-P 000 317-1755
Red 175 amp	1/0	6329G1	49150	000 317-1756-P 000 317-1756

Housing w/springs	Anderson Part #	Brad Harrison #	Anderson Original #
Gray 175 amp	940	66-0100	000 317-1072-P 000 317-1072
Blue 175 amp	941	66-0101	000 317-1073-P 000 317-1073
Orange 175 amp	942	66-0102	000 317-1077-P 000 317-1077
Yellow 175 amp	943	66-0103	000 317-1074-P 000 317-1074
Red 175 amp	949	66-0104	000 317-1080-P 000 317-1080

Contact Sets:	Wire AWG	Anderson Part #	Brad Harrison #
	1/0	944	66-0130
	#2	947	
	#4	948	

SB Connector 175 Amp 3-Pole Series

Housing w/springs & 3 contacts	Wire AWG	Anderson Part #	Anderson Original #
Gray 175 amp	1/0	6316	000 317-1710

Accessories	Wire AWG	Anderson Part #	Brad Harrison #	Anderson Original #
"A" Frame Handles		995G1	66-0370	000 317-1133
"A" Frame Handles		995G2	66-0371	000 317-1134
Manual Release-Battery		923	65-0134	000 317-1068
Manual Release-Charger		924	65-0135	000 317-1069
Key Charger		111197	65-0128	000 317-1070
Reducing Bushings	1/0 to #1	5687	56-0653	000 317-1135
	1/0 to #2	5690	56-0652	000 317-1136
Cable Clamps		945		000 317-1076

SB Connector 350 Amp Series

Dimensions
Metric dimensions are shown in italics (mm)

A	B	C	D	E	F	G	H	I
1.125	1.375	1.328	2.656	4.250	7.170	1.068	1.313	.265
<i>28.58</i>	<i>34.93</i>	<i>33.73</i>	<i>67.46</i>	<i>107.95</i>	<i>182.12</i>	<i>27.12</i>	<i>33.34</i>	<i>6.73</i>

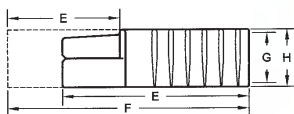
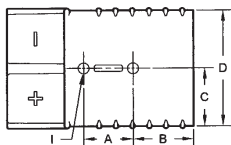

Housing w/springs & 2 contacts	Wire AWG	Anderson Part #	Brad Harrison #	Part #	Anderson Original #
Gray 350 amp	2/0	6320G1	49210	000 317-1722-P	000 317-1722
	3/0	6320G5	49211	000 317-1726-P	000 317-1726
	4/0	6320G2	49212	000 317-1723-P	000 317-1723
Blue 350 amp	2/0	6321G1	49220	000 317-1728-P	000 317-1728
	3/0	6321G5	49221	000 317-1732-P	000 317-1732
	4/0	6321G2	49222	000 317-1729-P	000 317-1729
Red 350 amp	2/0	6322G1	49250	000 317-1734-P	000 317-1734
	3/0	6322G5	49251	000 317-1735-P	000 317-1735
	4/0	6322G2	49252	000 317-1736-P	000 317-1736
Yellow 350 amp	2/0	6323G1	49240	000 317-1740-P	000 317-1740
	3/0	6323G5	49241	000 317-1741-P	000 317-1741
	4/0	6323G2	49242	000 317-1742-P	000 317-1742
Green 350 amp	2/0	6324G1	49260	000 317-1746-P	000 317-1746
	3/0	6324G5	49261	000 317-1750-P	000 317-1750
	4/0	6324G2	49262		000 317-1751

Housing w/springs	Anderson Part #	Brad Harrison #	Part #	Anderson Original #
Gray 350 amp	906	66-0110	000 317-1054-P	000 317-1054
Blue 350 amp	912	66-0111	000 317-1060-P	000 317-1060
Red 350 amp	913	66-0114	000 317-1061-P	000 317-1061
Yellow 350 amp	914	66-0113	000 317-1062-P	000 317-1062
Green 350 amp	931	66-0115	000 317-1071-P	000 317-1071
Orange 350 amp	932			000 317-1101

Contact Sets:	Wire AWG	Anderson Part #	Brad Harrison #	Part #
	2/0	907	66-0140	000 317-1055
	3/0	916	66-0141	000 317-1064
	4/0	908	66-0142	000 317-1056

Accessories	Wire AWG	Anderson Part #	Brad Harrison #	Part #
"A" Frame Handles		995G2	66-0371	000 317-1134
Manual Release-Lock Half		919/919G1	65-0136/0137	000 317-1065
Manual Release-Mount Half		922G1	65-0138	000 317-1067
Reducing Bushings	2/0 to 1/0	5918	56-0660	000 317-1141
Cable Clamps		996G1		000 317-1140
		911		000 317-1142



BATTERY
connectors



SBX Connector 175 Amp 2-Pole Series



Dimensions
Metric dimensions are shown in italics (mm)

A	B	C	D	E	F	G	H	I
1.125	.563	1.047	2.710	3.625	5.266	.750	1.000	.265
<i>28.58</i>	<i>14.28</i>	<i>26.59</i>	<i>68.83</i>	<i>92.08</i>	<i>133.75</i>	<i>19.00</i>	<i>25.4</i>	<i>6.73</i>

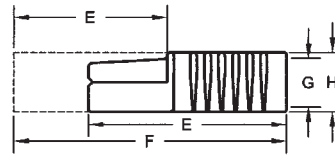
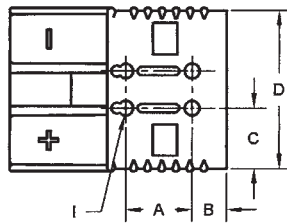

Housing w/springs & 2 contacts w/ auxiliary contact kit	Wire AWG	Anderson Part #	Brad Harrison #	Part #
---	----------	-----------------	-----------------	--------

Gray 175 amp	1/0	6370G1	59110/59300	000 317-1797
Blue 175 amp	1/0	6371G1	59120/59300	000 317-1798
Orange 175 amp	1/0	6372G1	59130/59300	000 317-1799
Red 175 amp	1/0	6378G1	59150/59300	000 317-1800

Contact Sets:	Wire AWG	Anderson Part #	Brad Harrison #	Part #
---------------	----------	-----------------	-----------------	--------

	1/0	6384G1		000 317-1811
--	-----	--------	--	--------------

Accessories	Wire AWG	Anderson Part #	Brad Harrison #	Part #
-------------	----------	-----------------	-----------------	--------

Auxiliary Contact Kit		6344	66-0370	000 317-1771
"A" Frame Handles		995G1	59300	000 317-1133
Reducing Bushings	1/0 to #1	5687	56-0653	000 317-1135
	1/0 to #2	5690	56-0652	000 317-1136



SBX Connector 350 Amp 2-Pole Series



Dimensions
Metric dimensions are shown in italics (mm)

A	B	C	D	E	F	G	H	I
1.125	1.359	1.328	3.281	4.922	7.170	1.063	1.300	.281
<i>28.58</i>	<i>34.51</i>	<i>33.73</i>	<i>83.34</i>	<i>125.01</i>	<i>182.12</i>	<i>26.99</i>	<i>33.02</i>	<i>7.14</i>

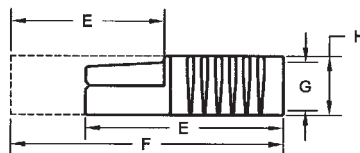
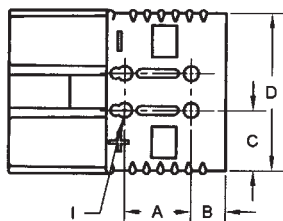

Housing w/springs & 2 contacts w/ auxiliary contact kit	Wire AWG	Anderson Part #	Brad Harrison #	Anderson Original #
Gray 350 amp	2/0	6340G1	59210/59300	000 317-1767
	35MM	6340G6		
Blue 350 amp	2/0	6341G1	59220/59300	000 317-1768
	35MM	6341G6		
Red 350 amp	2/0	6342G1	59250/59300	000 317-1769
	35MM	6342G6		
Green 350 amp	2/0	6343G1	59260/59300	000 317-1770
	35MM	6343G6		
Black 350 amp	2/0	6359G1	59270/59300	—
	35MM	6359G6		

Housing w/springs & 2 contacts	Wire AWG	Anderson Part #	Brad Harrison #	Anderson Original #
Gray 350 amp	2/0	6345G1	59210	000 317-1774
	35MM	6345G6		
Blue 350 amp	2/0	6346G1	59220	000 317-1772
	35MM	6346G6		
Red 350 amp	2/0	6347G1	59250	000 317-1773
	35MM	6347G6		
Green 350 amp	2/0	6348G1	59260	—
	35MM	6348G6		
Black 350 amp	2/0	6363G1	59270	—
	35MM	6363G6		



SBX Connector 350 Amp 2-Pole Series continued



Dimensions
Metric dimensions are shown in *italics* (mm)

A	B	C	D	E	F	G	H	I
1.125	1.359	1.328	3.281	4.922	7.170	1.063	1.300	.281
<i>28.58</i>	<i>34.51</i>	<i>33.73</i>	<i>83.34</i>	<i>125.01</i>	<i>182.12</i>	<i>26.99</i>	<i>33.02</i>	<i>7.14</i>

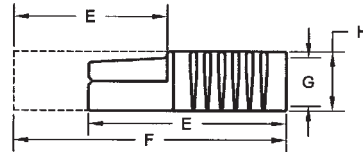
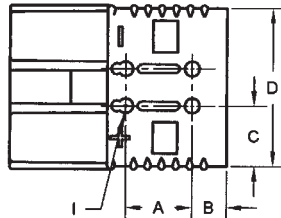

Contact Sets:	Wire AWG	Anderson Part #	Brad Harrison #	Part #
	2/0	6354	66-0340	000 317-5005
	3/0	6355	66-0341	000 317-1100

Accessories	Wire AWG	Anderson Part #	Brad Harrison #	Part #
Auxiliary Contact Kit		6344	59300	000 317-1771
"A" Frame Handles		995G2	66-0371	000 317-1134
Manual Release-Battery		993G1	65-0168	000 317-1776
Manual Release-Charger		994G1	65-0167	000 317-1775
Reducing Bushings	1/0 to 2/0	5918		000 317-1141



EC Connector Series



Dimensions

Metric dimensions are shown in *italics* (mm)

A	B	C	D	E	F	G	H	J
5.000	3.630	3.590	5.750	2.310	3.340	5.560	2.750	3.500
<i>127.0</i>	<i>92.1</i>	<i>91.3</i>	<i>146.1</i>	<i>58.7</i>	<i>84.9</i>	<i>141.3</i>	<i>69.9</i>	<i>88.9</i>

K	L	M	N	P
2.090	3.380	2.720	1.130	.270
<i>53.2</i>	<i>85.7</i>	<i>69.1</i>	<i>28.6</i>	<i>6.7</i>

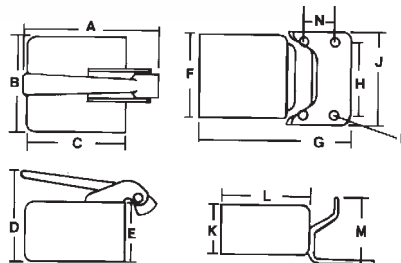

Connectors w/ 2 contacts	Wire AWG	Anderson Part #	Brad Harrison #	Part #
Locking Half	#2	5807B	49410	000 317-1608
	2/0	5810B	49411	000 317-1612
	4/0	5821B	49412	000 317-1629
Mounting Half	2/0	5816B	49431	000 317-1622
	4/0	5824B	49432	000 317-1623
Charging Half	#2	5801B	49450	000 317-1606
	2/0	5804B	49451	000 317-1605
	4/0	5827B	49452	000 317-1635

Housing	Anderson Part #	Brad Harrison #	Part #
Locking Half	5840	65-0141	000 317-1657
Mounting Half	5842	65-0143	000 317-1660
Charging Half	5841	55-0265	000 317-1658
Insulation Assembly	951	66-0171	000 317-1082

Contact Sets:	Wire AWG	Anderson Part #	Brad Harrison #	Part #
	#2	952	66-0180	000 317-1083
	2/0	953	66-0181	000 317-1084
	4/0	954	66-0182	000 317-1085



YC Connector Series

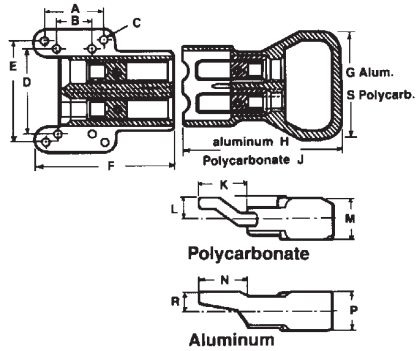

Dimensions

Metric dimensions are shown in *italics* (mm)

A	B	C	D	E	F	G	H	J
1.880	1.130	.270	2.750	3.250	4.440	3.880	5.700	5.880
<i>47.8</i>	<i>28.7</i>	<i>6.9</i>	<i>69.9</i>	<i>82.6</i>	<i>112.8</i>	<i>98.4</i>	<i>146.1</i>	<i>149.4</i>
K	L	M	N	P	R	S		
2.190	.970	1.750	2.000	1.750	.880	4.500		
<i>55.6</i>	<i>24.6</i>	<i>44.5</i>	<i>50.80</i>	<i>44.5</i>	<i>22.2</i>	<i>114.3</i>		

Connectors	Wire AWG	Anderson Part #	Brad Harrison #	Part #
Receptacle	#2	7205G3	49310	000 317-1856
	1/0	7205G1		000 317-1854
	2/0	7205	49312	000 317-1853
Plug (Aluminum)	2/0	7204	49332	000 317-1846
Plug (Polycarbonate)	#2	L7204G3	49330	000 317-1852
	2/0	L7204	49331	000 317-1851

Housings	Anderson Part #	Brad Harrison #	Part #
Housing-Receptacle (Phenolic) Standard	956	56-0671	000 317-1087
Housing-Receptacle (Phenolic) Auxiliary Contact	957	56-0672	000 317-1088
Housing-Receptacle (Aluminum)		962	000 317-1093
Housing-Plug (Polycarbonate)	L962	50-2191	000 317-1094

Receptacle	Wire AWG	Anderson Part #	Brad Harrison #	Part #
Contact Sets-Receptacle	#2	960	66-0160	000 317-1091
	2/0	958	66-0162	000 317-1089
Contact Sets-Plug Power (Aluminum)	#2	966	66-0150	000 317-1099
	2/0	964	66-0152	000 317-1097
Contact Sets-Plug Power (PolyCarbonate)	#2	966G1		000 317-1096
	2/0	961G1		000 317-1095



000 317-1065

1



LOCK HALF MANUAL RELEASE

Connector SeriesSB350

000 317-1067

2



MOUNT HALF MANUAL RELEASE

Connector SeriesSB350

000 317-1068

3



LOCK HALF MANUAL RELEASE

Connector SeriesSB175

000 317-1069

4



MOUNT HALF MANUAL RELEASE

Connector SeriesSB175

000 317-1070

5



CHARGER KEY

Connector SeriesSB175

000 317-1076

6



CABLE CLAMP

Connector SeriesSB175

000 317-1082

7



INSULATION ASSEMBLY

Connector SeriesEC

000 317-1132

8



HANDLE

Connector SeriesSB50



BATTERY

connector accessories

000 317-1133

1



HANDLE

Connector Series SB175/SBE160
Screws 1/4-20 x 1.500"

000 317-1134

2



HANDLE

Connector Series SB/SBX350/SBE320
Screws 1/4-20 x 1.750"

000 317-1135

3



REDUCING BUSHING

Connector Series SB/SBE/SBX
Wire Set 1/0 to #1

000 317-1136

4



REDUCING BUSHING

Connector Series SB/SBE/SBX
Wire Set 1/0 to #2

000 317-1140

5



CABLE CLAMP

Connector Series SB350

000 317-1141

6



REDUCING BUSHING

Connector Series SB175
Wire Set 2/0 to 1/0

000 317-1142

7



CABLE CLAMP

Connector Series SB350

000 317-1143

8



CABLE CLAMP

Connector Series SB50



000 317-1771

1



AUXILIARY CONTACT KIT

Connector SeriesSBE/SBX

000 317-1775

2



CHARGER HALF MANUAL RELEASE

Connector SeriesSBE320/SBX350

000 317-1776

3



BATTERY HALF MANUAL RELEASE

Connector SeriesSBE320/SBX350

000 351-1003

4



CRIMPING TOOL

000 317-SB175

5



NEW
Catalog Item!

LOCKOUT SB175

Manufacturer's # 126205-001

000 317-SB350

6



NEW
Catalog Item!

LOCKOUT SB350

Manufacturer's # 126206-001



1

Battery Chargers – On Board



Part #	Manufacturer	Voltage	Amps	Connector Type	Timer Type
IE-9015	LESTER	12V	10	No Plug	Manual
IE-9005	MAC	24V	15	SB50 Gray	Built-in
IE-9013	MAC	24V	15	SB175 Gray	Automatic
IE-9017	MAC	24V	15	SB175 Gray	Automatic
IE-9018	MAC	24V	15	SB175 Gray	Manual
IE-9014	MAC	24V	15	SB175 Gray	Built-in
IE-9008	LESTER	24V	25	No Plug	Manual
IE-9035	AMP	36V	25	No Plug	Built-in
IE-9060	LESTER	24V	25	No Plug	Manual

2

Battery Chargers – Stand Alone



Motor Appliance



Lester



Amp Max

Part #	Manufacturer	Voltage	Amps	Connector Type	Timer Type
IE-9034	AMP MAX	12V	40	No Plug	Automatic
IE-9033	AMP MAX	24V	25	No Plug	Automatic
IE-9026	LESTER	24V	25	No Plug	Automatic
IE-9039	AMP	24V	25	No Plug	Automatic
IE-9016	LESTER	24V	40	SB50 Gray	Automatic
IE-9028	AMP MAX	24V	40	No Plug	Automatic
IE-9036	AMP MAX	36V	25	No Plug	Automatic
IE-9037	AMP MAX	36V	40	No Plug	Automatic
IE-9004	MAC	12V, 24V, 36V, 48V	50, 40, 35, 25	SB175 Gray	Automatic

Battery Chargers - Portable



BATTERY chargers

Part #	Manufacturer	Voltage	Amps	Connector Type	Timer Type
IE-9048	LESTER	12V	10	SB50	Automatic
IE-9000	MAC	24V	17	SB50 Gray	Automatic
IE-9001	MAC	24V	20	SB50 Gray	Automatic
IE-9006	LESTER	24V	20	SB50 Gray	Manual
IE-9007	LESTER	24V	20	Rubber Molded Plug, Gray	Automatic
IE-9011	LESTER	24V	25	SB50 Gray	Automatic
IE-9029	LESTER	24V	25	No Plug	Automatic
IE-9031	LESTER	24V	25	No Plug	12 hour
IE-9042	LESTER	24V	25	No Plug	None
IE-9043	LESTER	24V	25	No Plug	None
IE-9047	QUICK CHARGE	24V	25	No Plug	None
IE-9030	LESTER	24V	40	No Plug	Automatic
IE-9032	LESTER	24V	40	No Plug	Manual
IE-9025	MAC	36V	25	No Plug	Automatic
IE-9002	MAC	36V	17	SB50 Gray	Automatic
IE-9003	MAC	36V	20	SB50 Gray	Automatic
IE-9010	LESTER	36V	20	Rubber Molded Plug, Gray	Automatic
IE-9009	LESTER	36V	25	SB50 Gray	Manual
IE-9012	LESTER	36V	25	Polycarbonate Shield Plug, Yellow	Manual
IE-9044	LESTER	36V	25	No Plug	None
IE-9027	LESTER	36V	40	No Plug	Automatic
IE-9046	LESTER	36V	40	No Plug	None
IE-9049	LESTER	48V	21	Special Plug	Automatic
IE-9040	LESTER	48V	25	SB50	None
IE-9041	LESTER	48V	25	No Plug	None
IE-9054	LESTER	24V	25	SB50 Gray	Automatic
IE-9057	LESTER	36V	25	Polycarbonate Shield Plug, Yellow	Automatic
IE-9058	LESTER	36V	40	Rubber Molded Plug, Gray	Automatic
IE-9059	LESTER	24V	25	Polycarbonate Shield Plug, Yellow	Automatic



BATTERY

charger accessories

Lift Truck Parts Professionals

000 308-7574

1



TIMER

Manufacturer MAC
Used With IE-9005 charger

IE-1249

2



BATTERY DISCONNECT SWITCH

IE-5022

3



FUSE

Manufacturer Lester
Amps 25

IE-5023

4



FUSE

Manufacturer Lester
Amps 40

IE-5040

5



HEAT SINK WITH DIODES

Manufacturer Lester

IE-5044

6



TIMER WITH PLATE

Manufacturer Lester
Type 12 Hour Manual

IE-5046

7



TIMER KIT

Manufacturer Lester
Type Electric
Input Voltage 115V AC
Output Voltage 36V DC

IE-5062

8



TIMER KIT

Manufacturer Lester
Type Electric
Input Voltage 115V AC
Output Voltage 36V DC



IE-5063

1



TIMER KIT

Manufacturer Lester
 Type Electric
 Input Voltage 115V AC
 Output Voltage 24V DC

IE-5064

2



RELAY

Manufacturer Potter Brumfield
 Voltage 24V

IE-5067

3



HEAT SINK KIT

Manufacturer Lester

IE-5162

4



HEAT SINK WITH DIODES

Manufacturer Lester

IE-5163

5



TIMER

Manufacturer Lester
 Type Electric
 Input Voltage 115V AC
 Output Voltage 48V DC

IE-5248

6



CAPACITOR

Manufacturer Lester
 MF 20.5

IE-5256

7



TIMER KNOB

Manufacturer Lester

IE-5278

8



RELAY

Manufacturer Potter Brumfield
 Voltage 12V



1

IE-5293



A/C PLUG

Manufacturer

2

IE-5299



TIMER KNOB

Manufacturer MAC

3

IE-5301



TIMER PLATE

Manufacturer MAC

4

IE-5400



CIRCUIT BOARD

Manufacturer AMP MAX
Voltage 24V

5

IE-5424



TIMER

Manufacturer Lester
Type Electric
Input Voltage 115V AC
Output Voltage 24V DC

6

IE-5425



TIMER

Manufacturer Lester
Type Electric
Input Voltage 115V AC
Output Voltage 48V DC

7

IE-9020



CHARGER CABLE WITH YELLOW END

Manufacturer Lester
Plug Yellow polycarbonate shield

8

IE-9021



CHARGER CABLE WITH GRAY END

Manufacturer Lester
Plug Gray rubber molded



BATTERY battery gauges

000 308-2036

1



BATTERY DISCHARGE INDICATOR / HOUR METER

Series 2000
 Lockout Yes
 # of Terminals None (4 wires)
 Case Diameter 2.050"
 Depth 2.200"
 Bezel Diameter 2.365"
 Mounting Diameter 2.063"
 Hour Meter Accumulated Time
 Clear Function Yes (via hidden switch)

Part #	Voltage
000 308-2024	24V
000 308-2036	36V
000 308-2048	48V

000 308-C1582-IK

2

NEW
Catalog Item!



INSTALLATION KIT

Series 803
 Manufacturer Curtis

000 308-C1584

3

NEW
Catalog Item!



BATTERY DISCHARGE INDICATOR & HOURMETER

Series 933
 Manufacturer Curtis
 Voltage 12-24V
 Lockout Yes
 # of Terminals Plug with 15 Terminals
 Case Diameter 2.050"
 Overall Depth 2.500"
 Bezel Diameter 2.220"
 Mounting Hole Diameter 2.063"

Part #	Voltage
000 308-C1580	24-48V

000 308-C1586

4

NEW
Catalog Item!



BATTERY DISCHARGE INDICATOR & HOURMETER

Series 802
 Manufacturer Curtis
 Voltage 12-24V
 Lockout No
 # of Terminals 6
 Case Diameter 2.050"
 Overall Depth 2.180"
 Bezel Diameter 2.300"
 Mounting Hole Diameter 2.063"

Part #	Voltage
000 308-C1582	24-36V
000 308-C1587	36-48V



000 308-C1588

1

NEW
Catalog Item!



BATTERY DISCHARGE INDICATOR & HOURMETER

Series 803
 Manufacturer Curtis
 Voltage 24-36V
 Lockout Yes
 # of Terminals Plug with 8 Terminals
 Case Diameter 2.050"
 Overall Depth 2.273"
 Bezel Diameter 2.300"
 Mounting Hole Diameter 2.063"

Part #	Voltage
000 308-C1589	36-48V

000 308-C2081

2

NEW
Catalog Item!



BATTERY DISCHARGE INDICATOR-ANALOG

Series 933
 Manufacturer Curtis
 Voltage All
 Lockout Yes
 # of Terminals 8
 Bezel Stainless Steel
 Case Diameter 2.050"
 Overall Depth 1.800"
 Bezel Diameter 2.300"
 Mounting Hole Diameter 2.063"

000 308-C2082

3

NEW
Catalog Item!



BATTERY DISCHARGE INDICATOR & HOUR METER

Series Engage II
 Manufacturer Curtis
 Voltage 12-48V
 Lockout Yes
 # of Terminals 8-pin Molex Plug
 Case Diameter 2.028"
 Depth 1.811"
 Bezel Diameter 2.362"
 Mounting Diameter 2.110"

000 308-C2082-IK

4

NEW
Catalog Item!



INSTALLATION KIT-MOLEX BASED

Series Engage II
 Manufacturer Curtis



000 308-C2083

1

NEW
Catalog Item!



BATTERY DISCHARGE INDICATOR & MAINTENANCE METER

Series	Engage II
Manufacturer	Curtis
Voltage	12-48V
Lockout	Yes
# of Terminals	8-pin Molex Plug
Case Diameter	2.028"
Depth	1.811"
Bezel Diameter	2.362"
Mounting Diameter	2.110"

000 350-9240

2

NEW
Catalog Item!



BATTERY DISCHARGE INDICATOR

Series	900
Voltage	24V
Lockout	No
# of Terminals	2
Case Diameter	1.130"
Depth	2.078"
Bezel Diameter	2.365"
Mounting Diameter	2.063"

Part #	Voltage
000 350-9120	12V
000 350-9360	36V
000 350-9480	48V
000 350-9720	72V

*Dual Voltage Available Upon Request

000 350-9330-AG

3



BATTERY DISCHARGE INDICATOR

Series	933
Voltage	Any
Lockout	No
# of Terminals	3
Case Diameter	2.076"
Depth	1.130"
Bezel Diameter	2.675"
Mounting Diameter	2.050"

000 350-9330-DG

4



BATTERY DISCHARGE INDICATOR

Series	933
Voltage	Any
Lockout	No
# of Terminals	3
Case Diameter	2.078"
Depth	1.130"
Bezel Diameter	2.365"
Mounting Diameter	2.050"



BATTERY battery gauges

000 350-C9120

1

NEW
Catalog Item!



BATTERY DISCHARGE INDICATOR-ANALOG

Series	900
Manufacturer	Curtis
Voltage	12V
Lockout	No
# of Terminals	2
Case Diameter	2.050"
Overall Depth	1.800"
Bezel Diameter	2.300"
Mounting Hole Diameter	2.063"

Part #	Voltage
000 350-C9240	24V
000 350-C9360	36V
000 350-C9480	48V
000 350-C9720	72V

000 350-C9330-AG

2

NEW
Catalog Item!



BATTERY DISCHARGE INDICATOR-ANALOG

Series	933
Manufacturer	Curtis
Voltage	All
Lockout	Yes
# of Terminals	3
Bezel	Black
Case Diameter	2.050"
Overall Depth	1.800"
Bezel Diameter	2.300"
Mounting Hole Diameter	2.063"

000 350-C9330-DG

3

NEW
Catalog Item!



BATTERY DISCHARGE INDICATOR-DIGITAL

Series	933
Manufacturer	Curtis
Voltage	All
Lockout	Yes
# of Terminals	3
Case Diameter	2.050"
Overall Depth	1.800"
Bezel Diameter	2.300"
Mounting Hole Diameter	2.063"

000 350-CGRD

4

NEW
Catalog Item!



METER GUARD

Series	All
Manufacturer	Curtis



000 351-4012

1



BATTERY VOLT METER

Voltage	12V
Lockout	No
# of Terminals	2
Case Diameter	2.030"
Depth	1.500"
Bezel Diameter	2.300"
Mounting Diameter	2.063"

000 351-4024

2



BATTERY VOLT METER

Voltage	24V
Lockout	No
# of Terminals	2
Case Diameter	2.030"
Depth	1.500"
Bezel Diameter	2.300"
Mounting Diameter	2.063"

000 351-4042

3



BATTERY VOLT METER

Voltage	36V/48V
Lockout	No
# of Terminals	2
Case Diameter	2.060"
Depth	1.365"
Bezel Diameter	2.280"
Mounting Diameter	2.063"

000 351-4046

4

NEW
Catalog Item!



BATTERY VOLT METER

Voltage	24V
Lockout	No
# of Terminals	2
Case Diameter	1.440"
Depth	2.300"
Bezel Diameter	1.940"
Mounting Diameter	2.040"



000 351-8212

1



**GUARDIAN
BATTERY DISCHARGE INDICATOR**

Lockout	Yes
# of Terminals	3
Case Diameter	2.050"
Depth	2.200"
Bezel Diameter	2.675"
Mounting Diameter	2.050"

Part #	Voltage
000 351-8212	12V
000 351-8224	24V
000 351-8236	36V
000 351-8248	48V

000 351-7890-24V

2



QUICK DISCONNECT

Series	QD
Voltage	24V
AWG	2/0

007 1769073

3



BATTERY VOLT METER

Voltage	24V
Lockout	No
# of Terminals	2
Case Diameter	2.030"
Depth	1.500"
Bezel Diameter	2.300"
Mounting Diameter	2.063"

Disconnect Switches

NEW
Catalog Item!



125 Series



250 Series



252 Series



402 Series

- Disconnect batteries or other power supplies quickly in the event of serious electrical faults.
- Primarily used with battery powered vehicles but also suitable with static power systems.
- Capable of safely rupturing full load battery chemicals in the event of an emergency.

CURTIS

Part #	Curtis #	Description	Amps
000 393-C125	ED125-1	Manual Disconnect Single Pole On/Off	125
000 393-C125A	ED125A-2	Manual Disconnect Single Pole On/Off with auxiliary contacts	125
000 393-C125AB	ED125AB	Manual Disconnect Single Pole On/Off with auxiliary contacts & magnetic blowouts	125
000 393-C125B	ED125B	Manual Disconnect Single Pole On/Off with magnetic blowouts	125
000 393-C125L	ED125L-1	Manual Disconnect Single Pole On/Off Lockable	125
000 393-C125LA	ED125LA	Manual Disconnect Single Pole On/Off Lockable with auxiliary contacts	125
000 393-C125LAB	ED125LAB	Manual Disconnect Single Pole On/Off Lockable with auxiliary contacts & magnetic blowouts	125
000 393-C125LB	ED125BL	Manual Disconnect Single Pole On/Off Lockable with magnetic blowouts	125
000 393-C250	ED250-1	Manual Disconnect Single Pole On/Off	250
000 393-C250A	ED250A	Manual Disconnect Single Pole On/Off with auxiliary contacts	250
000 393-C250AB	ED250AB	Manual Disconnect Single Pole On/Off with auxiliary contacts & magnetic blowouts	250
000 393-C250B	ED250B-1	Manual Disconnect Single Pole On/Off with magnetic blowouts	250
000 393-C250L	ED250L-1	Manual Disconnect Single Pole On/Off Lockable	250
000 393-C250LAB	ED250ABL	Manual Disconnect Single Pole On/Off Lockable with auxiliary contacts & magnetic blowouts	250
000 393-C250LB	ED250LB	Manual Disconnect Single Pole On/Off Lockable with magnetic blowouts	250
000 393-C252	ED252-1	Manual Disconnect Double Pole On/Off	250
000 393-C252A	ED252A	Manual Disconnect Double Pole On/Off with auxiliary contacts	250
000 393-C252AB	ED252AB	Manual Disconnect Double Pole On/Off with auxiliary contacts & magnetic blowouts	250
000 393-C252B	ED252B-1	Manual Disconnect Double Pole On/Off with magnetic blowouts	250
000 393-C252L	ED252L-1	Manual Disconnect Double Pole On/Off Lockable	250
000 393-C252LA	ED252LA	Manual Disconnect Double Pole On/Off Lockable with auxiliary contacts	250
000 393-C252LAB	ED252LAB	Manual Disconnect Double Pole On/Off Lockable with auxiliary contacts & magnetic blowouts	250
000 393-C252LB	ED252BL	Manual Disconnect Double Pole On/Off Lockable with magnetic blowouts	250
000 393-C402	ED402-1	Manual Disconnect Double Pole On/Off	400
000 393-C402A	ED402A	Manual Disconnect Double Pole On/Off with auxiliary contacts	400
000 393-C402L	ED402L-2	Manual Disconnect Double Pole On/Off Lockable	400
000 393-C402LA	ED402LA	Manual Disconnect Double Pole On/Off Lockable with auxiliary contacts	400



BATTERY disconnect switches



BATTERY jumper/booster cables

000 320-1000

1

NEW
Catalog Item!



EMERGENCY BOOSTER PACK

Manufacturer's # 604002-001
 Voltage 12V
 Current Draw 38 A/Hour
 Peak Current 1400 A
 Starting Current 800 A
 Weight 36.3 lbs.

2

NEW
Catalog Item!



000 320-1204
BOOSTER CABLE

Manufacturer's # 602500-001
 Cable Length 20'
 Cable Gauge 4 GA
 Current Draw 400 A

000 320-1302
BOOSTER CABLE

Manufacturer's # 602530-001
 Cable Length 30'
 Cable Gauge 2 GA
 Current Draw 500 A

000 320-1301
BOOSTER CABLE

Manufacturer's # 602540-001
 Cable Length 30'
 Cable Gauge 1/0 GA
 Current Draw 800 A

1

NEW
Catalog Item!



000 320-2002
JUMPER CABLE

Manufacturer's # 602280-001
Cable Length 20'
Cable Gauge 2 GA
Current Draw 500 A

000 320-2164
JUMPER CABLE

Manufacturer's # 602200-001
Cable Length 16'
Cable Gauge 4 GA
Current Draw 500 A

000 320-2204
JUMPER CABLE

Manufacturer's # 602205-001
Cable Length 20'
Cable Gauge 4 GA
Current Draw 400 A

000 320-2254
JUMPER CABLE

Manufacturer's # 602220-001
Cable Length 25'
Cable Gauge 4 GA
Current Draw 400 A

000 320-2201
JUMPER CABLE

Manufacturer's # 602330-001
Cable Length 20'
Cable Gauge 1 GA
Current Draw 500 A

000 320-2251
JUMPER CABLE

Manufacturer's # 602340-001
Cable Length 25'
Cable Gauge 1 GA
Current Draw 500 A

000 320-2301
JUMPER CABLE

Manufacturer's # 602360-001
Cable Length 30'
Cable Gauge 1 GA
Current Draw 500 A



BATTERY jumper/booster cables



BATTERY

933 Curtis controllers

1



933 Curtis Controllers

- Flashes red LED warning at 75% discharge.
- At 80% discharge, this instrument locks out the lift coil circuit.
- If 80% discharge is reached during a lift, the lift is completed before the lift circuit is locked out.
- Recognizes improperly charged battery.
- Non-volatile memory retains state of the charge level memory when external power is removed.
- Adjustable reset level and discharge profile (lockout point).
- Controller mounts to body of truck with two 1/4" bolts. The gauge is installed in the dash in a standard 2-1/16" round cut-out.
- Dual voltage models can be used with either of two different system voltages selectable with jumpers.
- Auto ranging, dual-voltage models automatically adjusts to the correct system voltage.

Part #	Curtis #	Description	Voltage	Type	Wire Length
000 350-C9331	933/3D24	Controller	24V		
000 350-C9331-CM		Controller & Meter	24V		
000 350-C9332	933/3D24AV	Controller	24V	Normally Closed Relay	
000 350-C9332-CM		Controller & Meter	24V		
000 350-C9333	933/3D36	Controller	36V		
000 350-C9333-CM		Controller & Meter	36V		
000 350-C9334	933/3D36AV	Controller	36V	Normally Closed Relay	
000 350-C9335	933/3D48	Controller	48V		
000 350-C9335-CM		Controller & Meter	48V		
000 350-C9336	933/3D48AV	Controller	48V	Normally Closed Relay	
000 350-C9343	933/3D2436	Controller	24-36V		
000 350-C9343-CM		Controller & Meter	24-36V		
000 350-C9344	933/3D2436AF	Controller	24-36V		
000 350-C9345	933/3D24AX	Controller	24V	Normally Open Relay	
000 350-C9347	933/3D3648	Controller	36-48V		
000 350-C9347-CM		Controller & Meter	36-48V		
000 350-C9348	933/3D3648AM	Controller	36-48V		
000 350-C9349	933/3D3648AV	Controller	36-48V	Normally Closed Relay	
000 350-C9349-CM		Controller & Meter	36-48V		
000 350-C9350	933/3D36AX	Controller	36V	Normally Open Relay	
000 350-C9351	933/3D48AX	Controller	48V	Normally Open Relay	
000 350-C9351-CM		Controller & Meter	48V		
000 350-C9331K-24		Installation Kit			24.000*
000 350-C9331K-42		Installation Kit			42.000*

000 350-C9330-AG

2



NEW
Catalog Item!

BATTERY DISCHARGE INDICATOR-ANALOG

Used With 933 Controllers
Voltage All

000 350-C9330-DG

3



NEW
Catalog Item!

BATTERY DISCHARGE INDICATOR-DIGITAL

Used With 933 Controllers
Voltage All



BATTERY 933 replacement controllers

1

BATTERY CONTROLLER



Part #	Voltage	Solid State / Relay	Lift Lock Out
000 350-9330	12V	Solid State	Yes
000 350-9331	24V	Solid State	Yes
000 350-9332	24V	Relay	Yes
000 350-9333	36V	Solid State	Yes
000 350-9334	36V	Relay	Yes
000 350-9335	48V	Solid State	Yes
000 350-9336	48V	Relay	Yes
000 350-9337	72V	Solid State	Yes
000 350-9339	12-48V	Solid State	Yes
000 350-9340	12-48V	Relay	Yes

2

000 350-9330-DGK



MODEL 933 DIGITAL METER KIT

Length 60.000"
Wire Gauge 18

3



**000 350-9330-K
BATTERY INTERRUPT KIT**

Input Voltage 12V

**000 350-9331-K
BATTERY INTERRUPT KIT**

Input Voltage 24V

**000 350-9333-K
BATTERY INTERRUPT KIT**

Input Voltage 36V

000 350-9330-AG

4



BATTERY DISCHARGE INDICATOR-ANALOG

Replacement For 933
Voltage Any

5

000 350-9330-DG



BATTERY DISCHARGE INDICATOR-DIGITAL

Replacement For 933
Voltage Any



BATTERY

DC to DC converters

000 439-1011

1



DC TO DC CONVERTER

Manufacturer GE
 Input Voltage 24-48V
 Output Voltage 12V
 Amps 16

000 439-1012

2



DC TO DC CONVERTER

Manufacturer GE
 Input Voltage 72-80V
 Output Voltage 12V
 Amps 16

000 439-1124

3



DC TO DC CONVERTER

Manufacturer Sevcon
 Input Voltage 36/48V
 Output Voltage 12V
 Watts 180

000 439-8006

4



DC TO DC CONVERTER

Manufacturer Sevcon
 Input Voltage 36/48V
 Output Voltage 12V
 Watts 180/300

000 439-8009

5



DC TO DC CONVERTER

Manufacturer CC Power
 Input Voltage 36V
 Output Voltage 12V
 Watts 200

000 439-8010

6



DC TO DC CONVERTER

Manufacturer CC Power
 Input Voltage 48V
 Output Voltage 12V
 Watts 200

000 439-8011

7



DC TO DC CONVERTER

Manufacturer CC Power
 Input Voltage 48V
 Output Voltage 12V
 Watts 400

000 439-8012

8



DC TO DC CONVERTER

Manufacturer CC Power
 Input Voltage 36V
 Output Voltage 12V
 Watts 400



000 439-C8034

1



NEW
Catalog Item!

DC TO DC CONVERTER

Manufacturer Curtis
 Input Voltage 24-36V
 Output Voltage 12V
 Watts 375W

000 439-C8054

2



NEW
Catalog Item!

DC TO DC CONVERTER

Manufacturer Curtis
 Input Voltage 48-60V
 Output Voltage 13.5V
 Watts 375W

Cables

000 351-2164

3



BATTERY CABLE

Length 42.500"
 Polarity Positive
 Wire Gauge Approximately 1 (Metric 40SQMM)

000 351-2169

4



BATTERY CABLE

Length 24.500"
 Polarity Negative
 Wire Gauge Approximately 1 (Metric 33SQMM)

000 351-2170

5



BATTERY CABLE

Length 55.750"
 Polarity Positive
 Wire Gauge Approximately 1 (Metric 33SQMM)

000 351-2172

6



BATTERY CABLE

Length 31.500"
 Polarity Negative
 Wire Gauge Approximately 1 (Metric 33SQMM)



BATTERY
cables

000 351-2232

1



BATTERY CABLE

Length 33.250"
Polarity Positive
Wire Gauge 1

000 351-2256

2



BATTERY CABLE

Length 56.750"
Polarity Positive
Wire Gauge Approximately 2 (Metric 30SQMM)

000 351-2415

3



BATTERY CABLE

Length 14.718"
Polarity Negative
Wire Gauge 4

000 351-2418

4



BATTERY CABLE

Length 18.000"
Polarity Positive / Negative
Wire Gauge 6

000 351-2424

5



BATTERY CABLE

Length 26.875"
Polarity Negative
Wire Gauge 4

000 351-2425

6



BATTERY CABLE

Length 26.500"
Polarity Positive
Wire Gauge 1

000 351-2430

7



BATTERY CABLE

Length 30.000"
Polarity Negative
Wire Gauge 1/0

000 351-2435

8



BATTERY CABLE

Length 31.000"
Polarity Positive
Wire Gauge 4



BATTERY
cables

000 351-2437

1



BATTERY CABLE

Length 37.750"
Polarity Negative
Wire Gauge 1

000 351-2444

2



BATTERY CABLE

Length 43.000"
Polarity Negative
Wire Gauge 2

000 351-2445

3



BATTERY CABLE

Length 46.000"
Polarity Positive
Wire Gauge 4

000 351-2446

4



BATTERY CABLE

Length 43.000"
Polarity Negative
Wire Gauge 2

000 351-2448

5



BATTERY CABLE

Length 48.000"
Polarity Positive
Wire Gauge 3

000 351-2456

6



BATTERY CABLE

Length 56.500"
Polarity Negative
Wire Gauge 1/0

000 369-4024

7



BATTERY CABLE

Length Pos: 31.000"/Neg 15.210"
Polarity Positive / Negative
Connector 50A Gray Connector
Wire Gauge 6

000 618-6058

8



BATTERY CABLE

Length 54.750"
Polarity Negative
Wire Gauge Approximately 1 (Metric 40SQMM)



BATTERY

hydrometer / holders & accessories

Hydrometer

000 351-1002

1



HYDROMETER (BATTERY TESTER)

Highly accurate temperature compensating battery tester.
Easy to use.

HOLDERS & ACCESSORIES

000 323-1000

2



NEW
Catalog Item!

BATTERY WATER DEIONIZER

Cleans standard tap water allowing use in lead batteries.
Removes iron and other trace mineral that can shorten battery life. One cartridge cleans approximately 600 gallons.

000 323-1000-F

3



NEW
Catalog Item!

DEIONIZER FILTER CARTRIDGE

Replacement for 000 323-1000

000 323-1001

4



NEW
Catalog Item!

BATTERY WATERING GUN

Insert into the battery cell and pull trigger to automatically fill the cell to the correct level and then shuts off. Never overfills battery cell.

000 351-1001

5



FOUR TRAY METAL BATTERY HOLDER

Size 7-1/4" X 10-3/4"
Includes 2 each 000 351-3885 and 000 351-3887



000 351-1004

1



NEW
Catalog Item!

TWO TRAY PIVOT BATTERY HOLDER

Size 7" x 10-7/8"

000 351-3881

2



BATTERY HOLD DOWN CLAMP
Non-adjustable

Size 10-1/2"

000 351-3885

3



RUBBER GROMMET

000 351-3886

4



BATTERY SUPPORT
Slides securely on a 1" diameter shaft

Size 7" x 10-1/2"

000 351-3887

5



RUBBER GROMMET

000 351-3888

6



NEW
Catalog Item!

BATTERY HOLD DOWN CLAMP
Non-adjustable

Size 8"

000 351-3889

7



NEW
Catalog Item!

BATTERY TRAY LEVER

Used With 000 351-1004

000 351-4045

8



NEW
Catalog Item!

BATTERY HOLD DOWN CLAMP
Non-adjustable

Size 4-1/4"



BATTERY

holders & accessories / battery chemicals

000 761-1161

1



NEW
Catalog Item!

BATTERY ROLLER ASSEMBLY

Battery Chemicals

CH-7011

2



BATTERY PROTECTOR

CH-7012

3



BATTERY CLEANER